

 → **CIVIL SLEEVES INSTALLATION GUIDE**

There are several methods which can be used to install Hawke Civil Sleeves, each method giving an inspectable professional finish to any cable/pipe penetration.

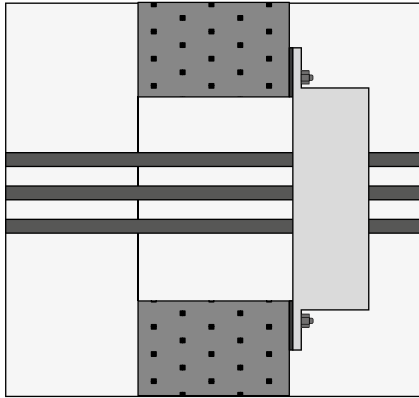

Figure 1

The sleeve can be bolted to wall and floors.

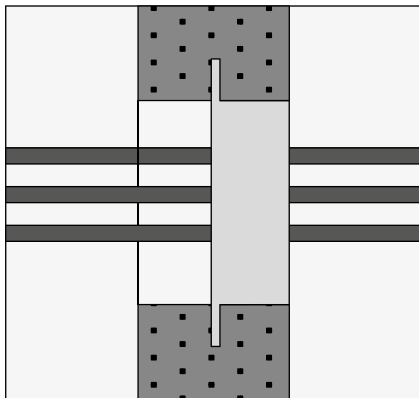

Figure 2.a

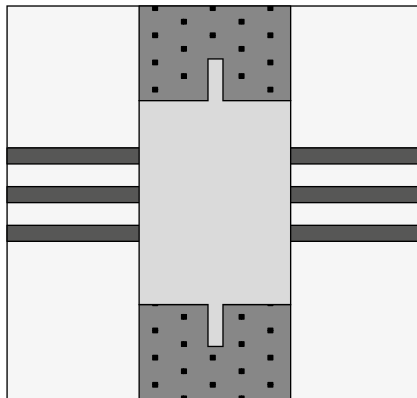

Figure 2.b

The sleeve can be casted directly into a wall or floor.

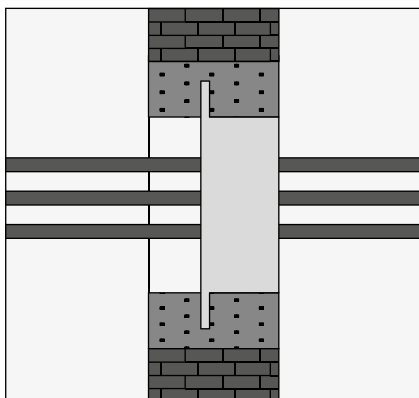

Figure 3.a

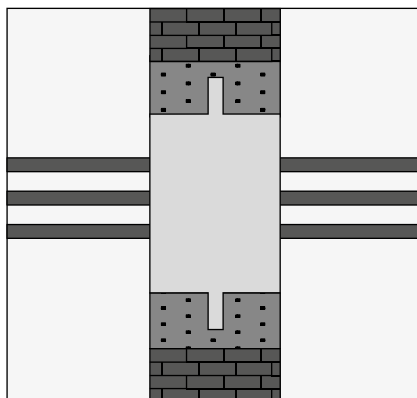

Figure 3.b

The sleeve may be cast into a concrete jacket. This method being normally used for brick and blockwork walls which in turn is fixed into the wall or floor.

CASTED

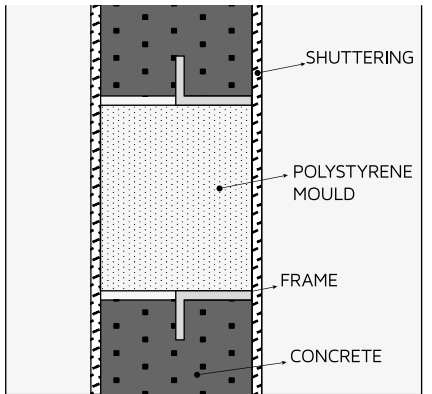

Figure 1.a

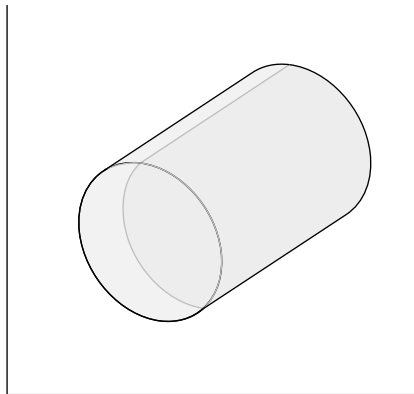

Figure 1.b

For Hawke sleeves which are cast into a wall or floor it is recommended that a Hawke Round Moulds is used. Hawke moulds are available to suit sizes 30, 40, 50, 70, 100, 125, 150, 175 and 200 with 300mm lengths and may be cut to suit the deep of the wall or floor as required.
(See catalogue page...79)

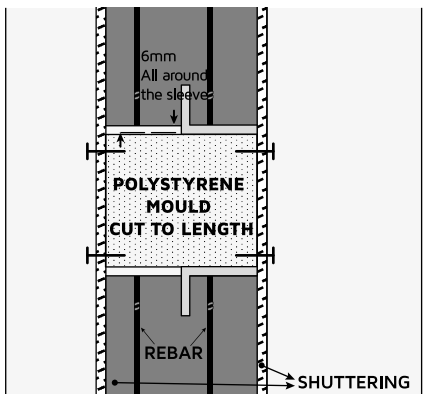

Figure 2.a

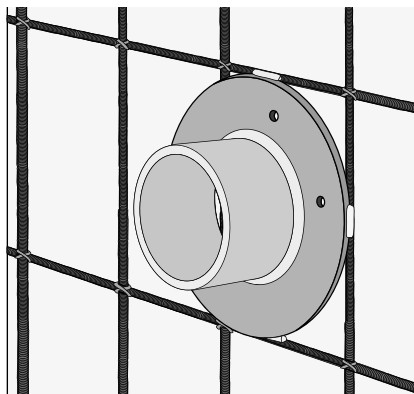

Figure 2.b

Sleeves and moulds require support to ensure that the correct position is maintained whilst the concrete is being poured. This may be achieved by nailing through the shuttering into the mould (if used) and fixing the frame to the rebar.

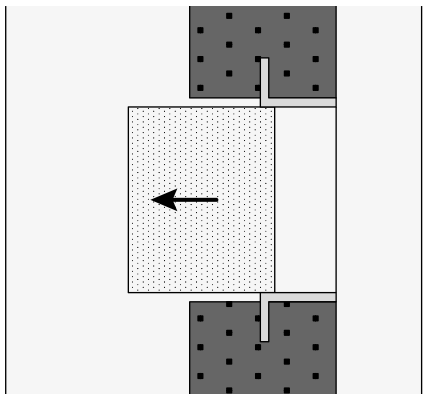

Figure 3

When all shuttering and other formwork has been removed, the polystyrene mould must be removed prior to electrical installation.

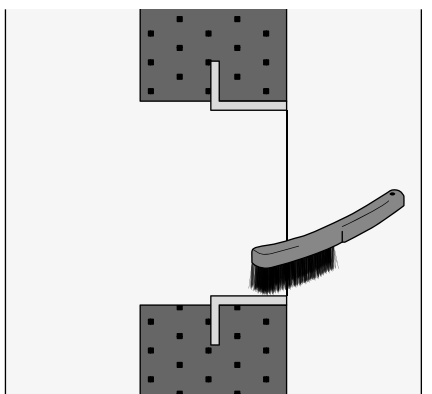

Figure 4

The transit aperture should be cleaned to remove any concrete or other debris that may have contaminated the apertures internal faces.

BOLTED

Sleeves can be bolted to floors and walls in either of the options showed below (CBO Sleeves, open version, can not be reverse fixed).

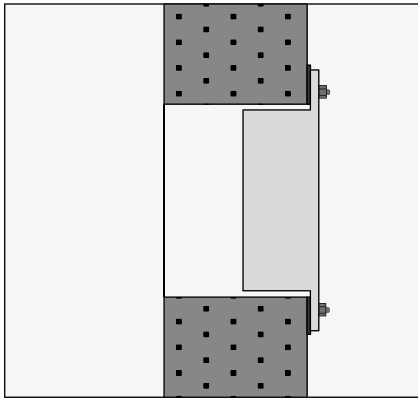

Figure 1.a

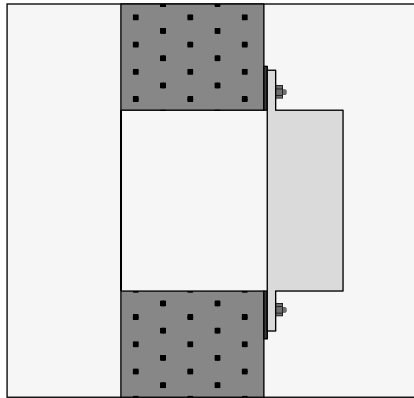

Figure 1.b

Size to fixing holes and type of fastener are to be established by the civil contractor dependent on size of sleeve weight and structure to which it is to be fixed.

When fixing sleeves to concrete/brick type structure care should be take if using expanding type fixings as they could burst into the aperture.

For bolted installations Intumescent Mastic or Hawke Fireproof Silicone (See page...78 catalogue) should be inserted between the sleeves flange and the structure.

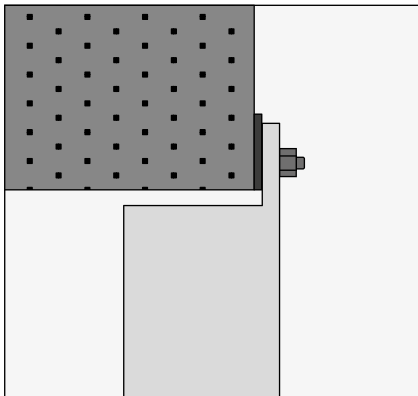

Figure 2.a

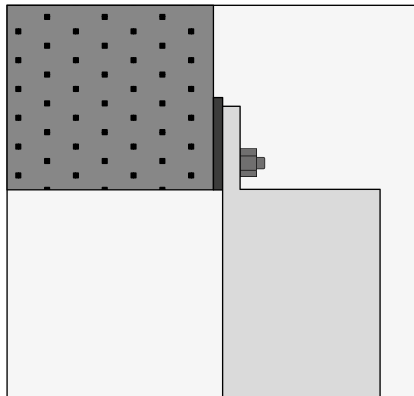

Figure 2.b

Prior to application of sealant ensure that faces to be sealed are dry and free from grease and any loose material, ensure that transit sleeve mates up with any fixings/holes already present checking especially the apertures over which the sleeve is to be mounted. (See minimum aperture dimensions table).

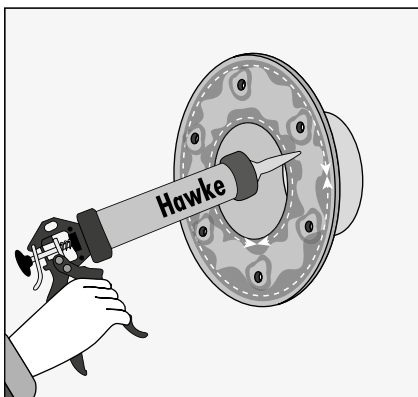

Figure 3.a

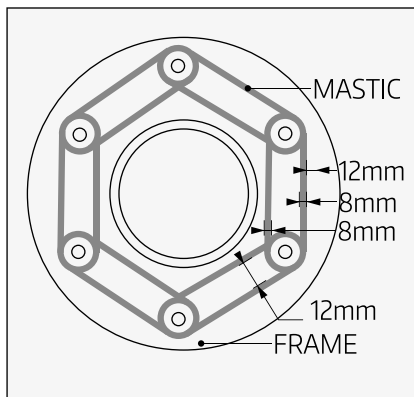

Figure 3.b

Cut nozzle on Mastic/Silicone tube to produce a bead diameter of aproximatly 8mm.

Apply two parallel rows of mastic and run a bead of mastic around each hole, as show below.

The Mastic/Silicone can be applied to front or rear of the frame dependant on the installation.
See Fig.1 and Fig.2.

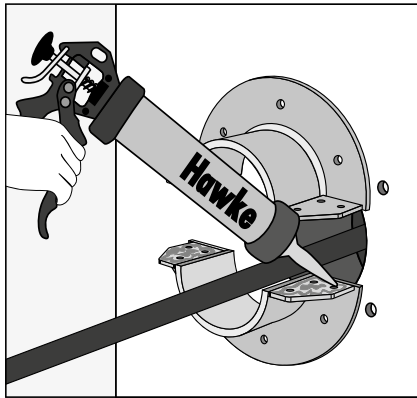

Figure 4.a

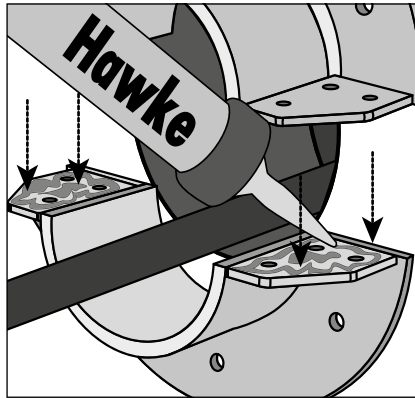

Figure 4.b

If CBO open sleeve is used, Mastic/Silicone should be applied also in all bolting areas of the removable end as showed below.

The sleeve can now be placed over its fixings and fasteners tightened to clamp the sleeve to the wall/floor.

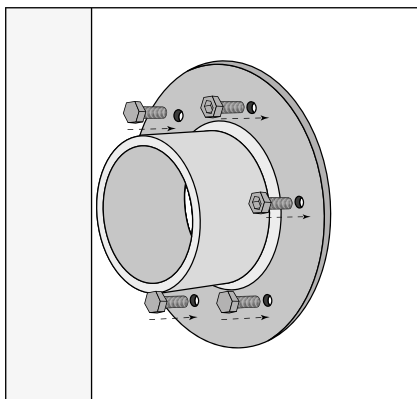

Figure 5

When tightened up to the required amount, the Mastic/Silicone should be faced off to the frame leaving a fillet of Mastic/Silicone around external edges of the frame.

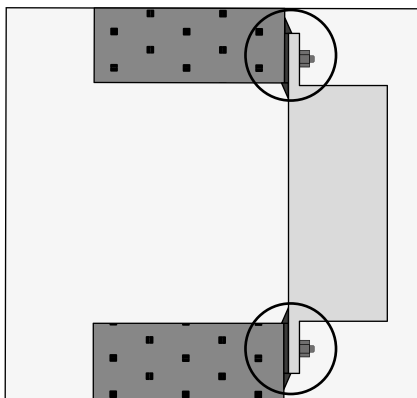

Figure 6